



**PRO-FLEX**

Sindalsvej 5, 8240 Risskov



**PRO-FLEX**



# MULTI-FLEX range



Our MULTI-FLEX sanding system with detachable sanding brushes offers an extremely flexible sanding system. The core is made of a special plastic material known as POM (polyoxymethylene). This is resistant to various chemicals and can therefore be used in various coating machines. Grooves are cut into the POM core. The brushes are made of tampico fibre and slot into the grooves in the POM core. All the brushes are available with or without abrasive cloth.

**The Multi-Flex sanding system** includes brushes for sanding with **all cores** on the market. The brushes can also be used with many other types of core. Sanding brushes for the above systems are available in the same brush height as those for the Multi-Flex system.

All sanding brushes are supplied with the type of sanding cloth you require and that we jointly regard as the best for your sanding work!

**Central core (diameter):**

50mm (10 hubs) - 80mm (20 hubs) - 100mm (20 hubs) - 120mm (24 hubs) - 180mm (36 hubs) - 280mm (54 hubs)

**Flangels:**

Can be supplied with all sizes and types of holes.

**Brushes:**

Dimensions (total height): 30mm - 40mm - 45mm - 55mm - 70mm - 85mm

**Slit width:**

Sanding widths available in all types of sanding cloth: 3mm - 4mm - 5mm - 7mm - 14mm - 20mm - special requests!

**Grain size:**

Standard grain size sanding brushes supplied as standard within: 60 - 500

## SINGLE BRUSHES WITH CLOTH - SINGLE ROW BRUSH

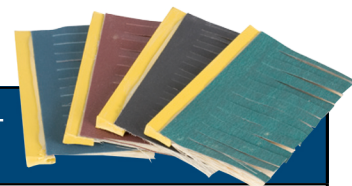

**F20**

Ideal for edge and sheet sanding.

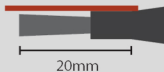

**F25**

Ideal for edge and sheet sanding.

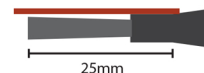

**F30**

Ideal for edge and sheet sanding.



**F40**

Good for burr and intermediate sanding.

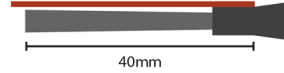

**F45**

Good for intermediate sanding.



**F55**

Ideal for intermediate sanding and sandings of profiles.

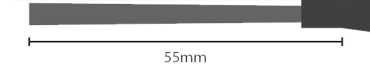

**F70**

Ideal for fine sanding and soft sanding of deep profiles.



**F85**

Ideal for soft sanding of very deep profiles.



## SANDING CLOTH ALWAYS IN STOCK:

**Aluminium Oxide:**  
Used for WOOD and LAQUER sanding.

**Silicon Carbide:**  
Used for LAQUER sanding.

**Ceramic:**  
Used for METAL sanding.

**SIA:**  
 2936 JJ  
 2937 JJ  
 2946 JJ  
 2747 JJ

**Deerfos:**  
 JA512  
 JC 122

**Ceramic sanding material:**  
 052 J

**Cora/Flexovit:**  
 KF 376

**Starcke:**  
 531 J  
 942 J

## TWIN BRUSH WITH CLOTH - TWIN ROW BRUSH



**F30T**

Ideal for burr sanding. The twin brush provides extra support thanks to its 2 rows of bristles, making it good for sanding MDF and UV coatings.

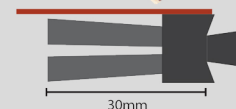

**F40T**

Versatile brush with extra support thanks to its 2 rows of bristles. Good for MDF and UV coatings.

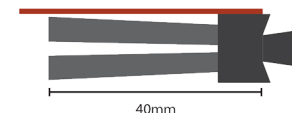

**F55T**

Ideal for intermediate and burr sanding. The twin brush provides excellent support.



**F70T**

Ideal fine sanding and soft sanding of deep profiles. The 2 rows of bristles provide extra support.

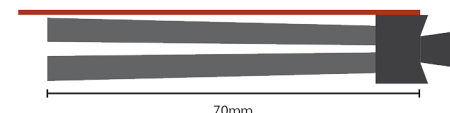

## CORES AND FLANGES FOR MULTI-FLEX SANDING SYSTEMS

All our cores are made from plastic material POM. POM is resistant to chemicals and can therefore be used in various coating machines. Our cores are available in 5 standard sizes: 80 mm - 100 mm - 120 mm - 180 mm and 280 mm. The maximum length is 650 mm, but all cores can be combined using intermediate flanges (CF-flange) to achieve the required length.

Cores can be supplied in aluminium if required. Both POM and aluminium cores can be supplied with a spiral groove by arrangement.

The end flanges are available with holes in all sizes and types. We recommend using a special Q-flange at one end. This special flange allows quick and easy replacement of sanding brushes without having to remove the entire core from the machine. This saves time, allowing you to get your machine back in operation more quickly! Please contact us to have us help determine the right size you need. Cores with a specific diameter can be manufactured on request; Just ask!

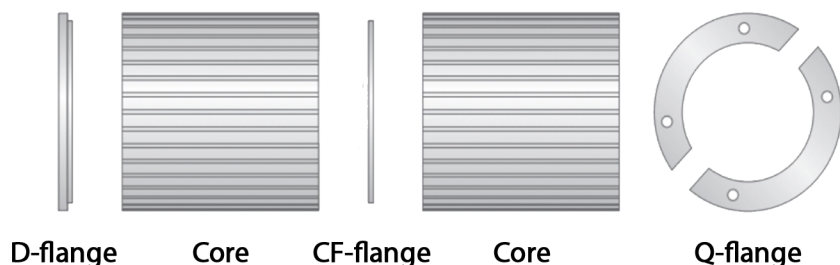
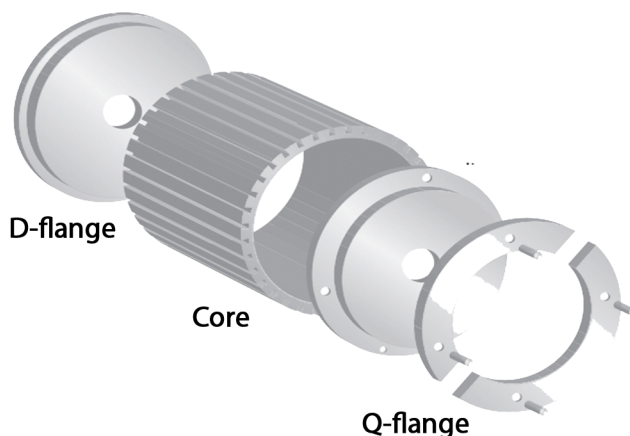

## PRO-FLEX range

### SANDING BRUSHES WITH SPINDLES



MODEL	NUMBER OF BRISTLE ROWS	SIZE	SPINDLE MEASUREMENT	SLIT WIDTH	GRAIN SIZE	CORE DIMENSIONS	BRUSH LENGTH	SANDING CLOTH LENGTH
B1	23	155 x 50 /	P6/P8	3 - 4 - 5 - 7 - 14 - 20mm	60-500	72mm x 50mm	37,5mm	41,5mm
B2	23	155 x 70 /	P6/P8	3 - 4 - 5 - 7 - 14 - 20mm	60-500	72mm x 50mm	37,5mm	41,5mm
B3	23	155 x 100 /	P6/P8	3 - 4 - 5 - 7 - 14 - 20mm	60-500	72mm x 100mm	37,5mm	41,5mm
B8	23	155 x MISC. SPEC.		3 - 4 - 5 - 7 - 14 - 20mm	60-500			
B11	23	160 x 50 /	P6/P8	3 - 4 - 5 - 7 - 14 - 20mm	60-500	72mm x 50mm	40mm	44mm
B12	23	160 x 70 /	P6/P8	3 - 4 - 5 - 7 - 14 - 20mm	60-500	72mm x 70mm	40mm	44mm
B13	23	160 x 100 /	P6/P8	3 - 4 - 5 - 7 - 14 - 20mm	60-500	72mm x 100mm	40mm	44mm
B14	23	160 x MISC. SPEC.		3 - 4 - 5 - 7 - 14 - 20mm	60-500			
B21	23	200 x 50 /	P8	3 - 4 - 5 - 7 - 14 - 20mm	60-500	72mm x 50mm	60mm	64mm
B22	23	200 x 70 /	P8	3 - 4 - 5 - 7 - 14 - 20mm	60-500	72mm x 70mm	60mm	64mm
B23	23	200 x 100 /	P8	3 - 4 - 5 - 7 - 14 - 20mm	60-500	72mm x 100mm	60mm	64mm
B25	23	200 x MISC. SPEC.		3 - 4 - 5 - 7 - 14 - 20mm	60-500			
B26	23	220 x 50 /	P8	3 - 4 - 5 - 7 - 14 - 20mm	60-500	72mm x 50mm	70mm	74mm
B27	23	220 x 70 /	P8	3 - 4 - 5 - 7 - 14 - 20mm	60-500	72mm x 70mm	70mm	74mm
B28	23	220 x 100 /	P8	3 - 4 - 5 - 7 - 14 - 20mm	60-500	72mm x 100mm	70mm	74mm
B29	23	220 x MISC. SPEC.		3 - 4 - 5 - 7 - 14 - 20mm	60-500			

P6 = 6mm Ø SPINDLE, P8 = 8mm Ø SPINDLE

# PRO-FLEX SANDING BRUSHES

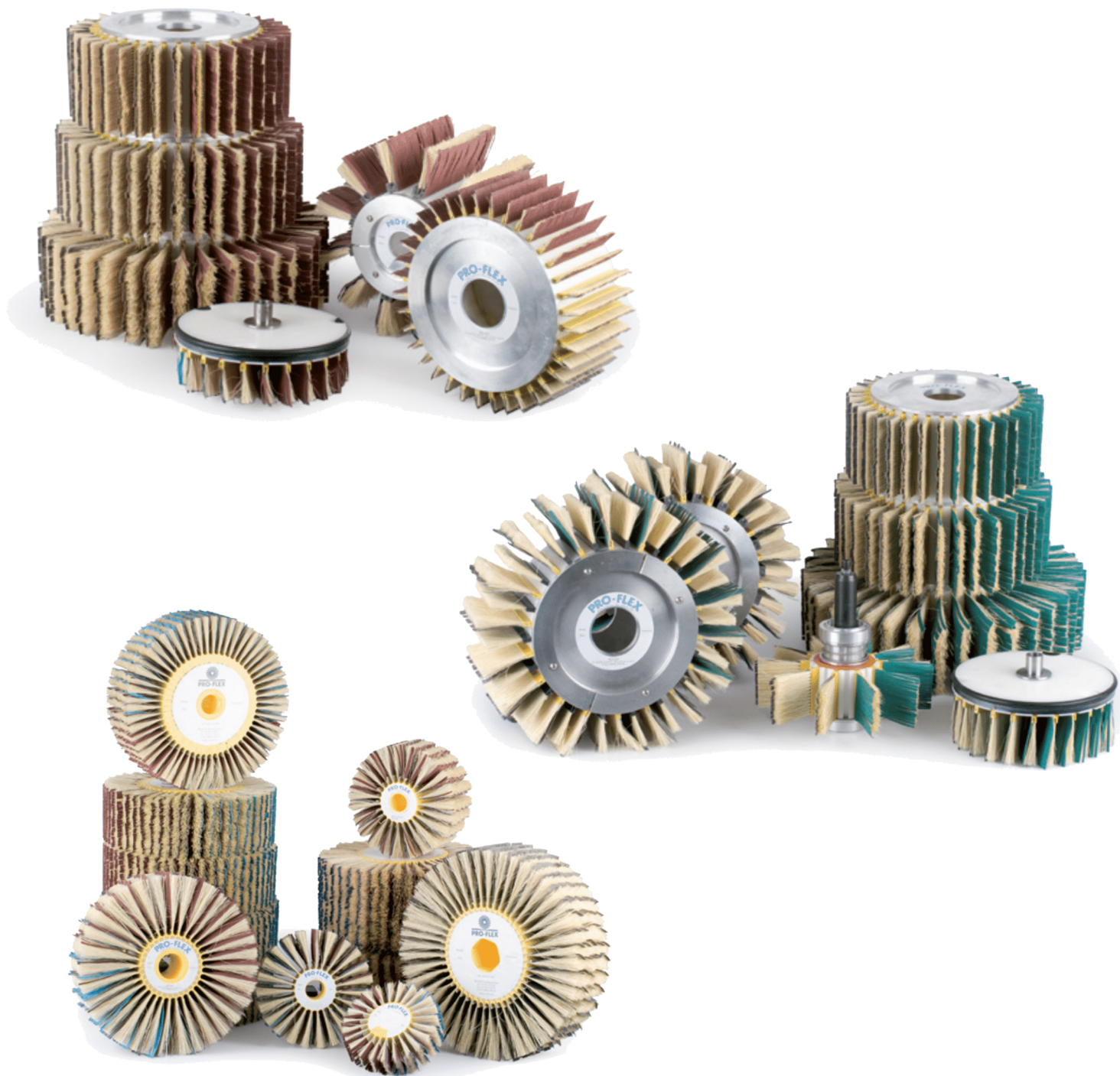

**PRO-FLEX**

Sindalsvej 5, 8240 Risskov

Info@pro-flex.dk

+45 86 16 49 02

# MULTI-FLEX product range



## POM or Aluminium discs

Can be made in 3 standard sizes:

- **Ø125mm** with **12 keyways**, each **40mm** long.
- **Ø180mm** with **24 keyways**, each **60mm** long.
- **Ø210mm** with **24 keyways**, each **75mm** long.

All size holes can be made in the discs.

On request special diameters is possible.

Ask for more info.

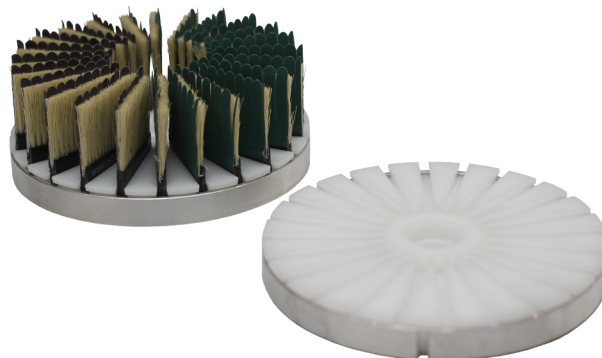

## POM Angleheads

Can be made in 2 standard sizes:

- **Ø120mm/Ø170mm** with **24 keyways**, each 30mm long.  
(Connects with Ø120mm cores.)
- **Ø180mm/Ø210mm** with 36 keyways, each 30mm long.  
(Connects with Ø180mm cores.)

All size holes can be made in the Angleheads.

Special diameters on request is possible.

Ask for more info.



## Zik-zak brushes

Possibilities are many:

Tynex\*, Horsehair, Steel, Pighair, Tampico etc.

\*Tynex can be made in all grit sizes, lengths and bristles.

Ask for more info.



## Speciaal brushes - Can be made to fit our cores

Can be made with many different fiber materials (Tynex, Horsehair, Pighair & Tampico brushes). Zig-Zak brushes are made in many different diameters, densities and can be made to fit all shaft.

Ask for more info.





**PRO-FLEX**

Sindalsvej 5, 8240 Risskov

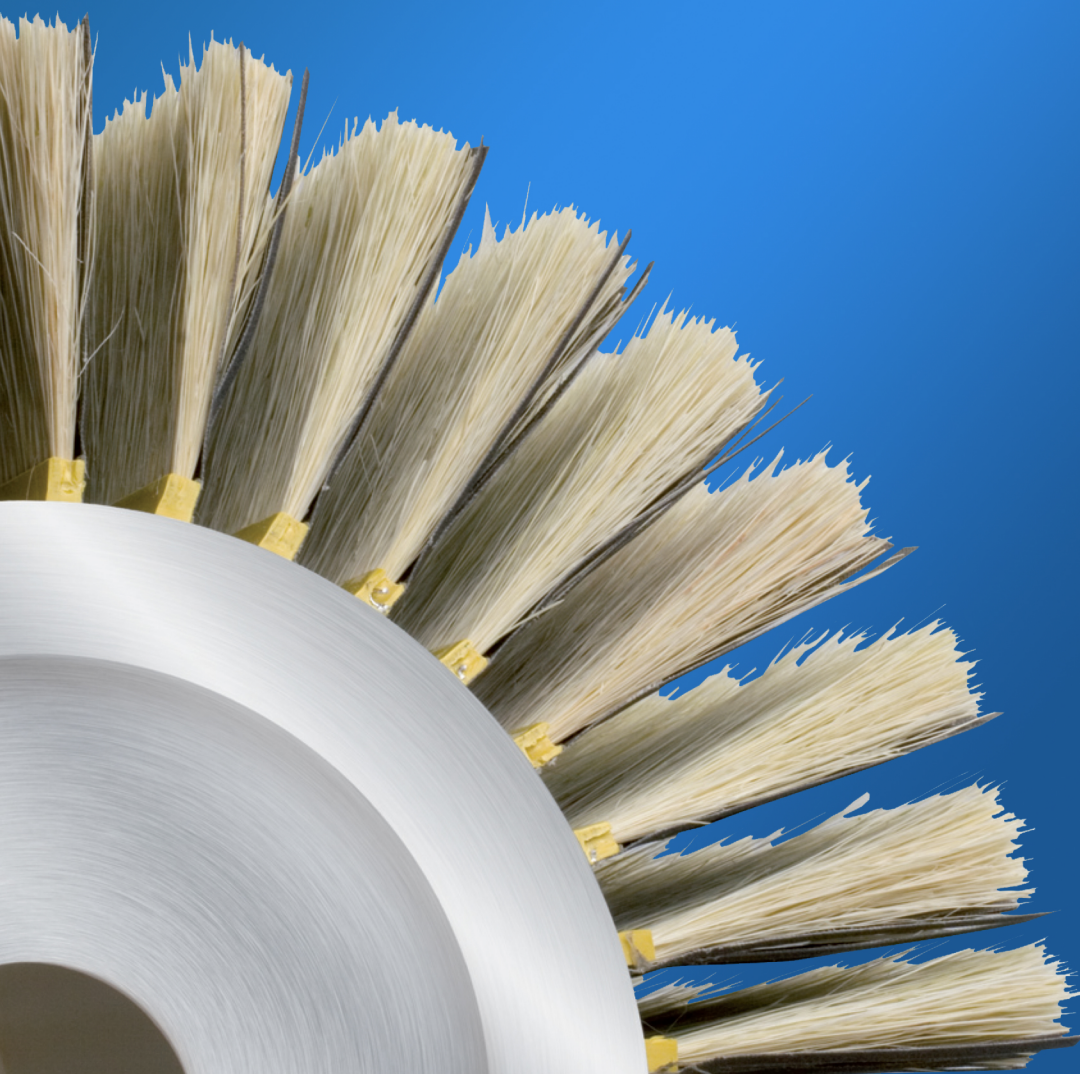

**PRO-FLEX**